

1		
Description	Material	Finish
Body	Brass	Nickel
Socket	BE CU	Gold
Insulation	Teflon	Teflon

SIDE VIEW

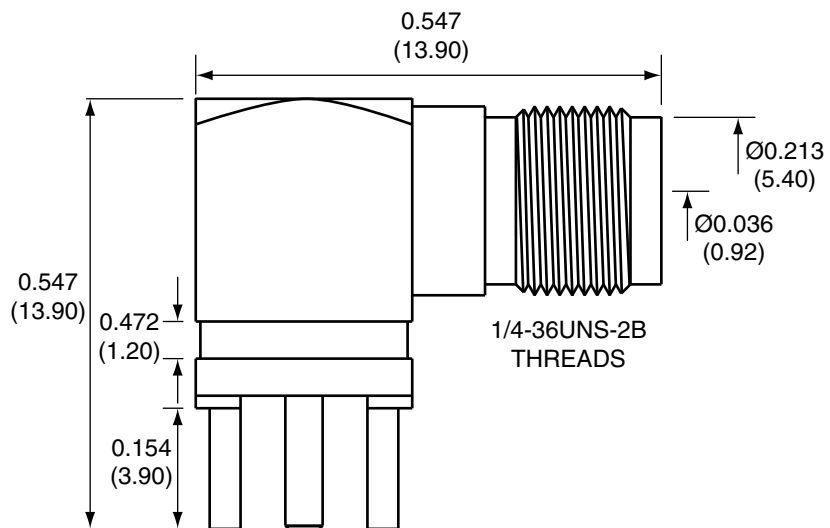

BACK VIEW

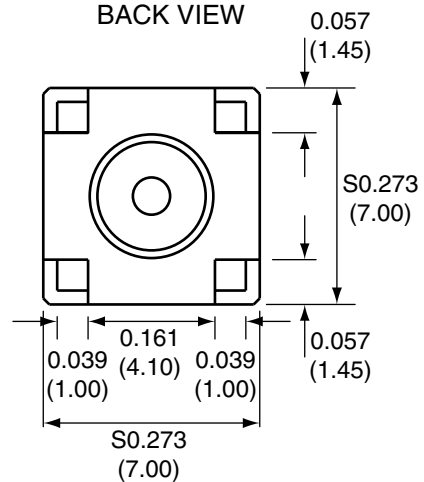

RECOMMENDED FOOTPRINT

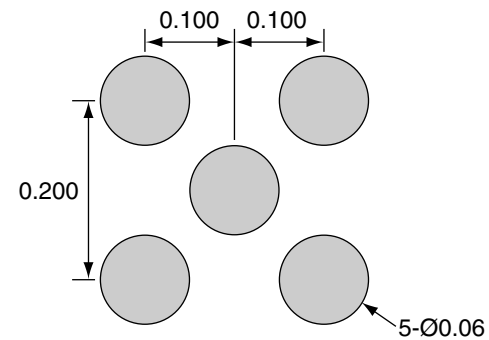

Title		SMA FEMALE RIGHT ANGLE PCB MOUNT		CONNECTOR CITY 159 ORT LANE MERLIN, OR 97532 PH (541)-471-6256 FAX (541)-471-6251	
Part No.	CON SMA002	Revision:	1.0		
Dimensions:	INCHES (mm)	Date:	6/2/2006	Sheet 1 of 1	

**CONNECTOR CITY**  
THE VALUE OF CONNECTIONS